









1  M8*16mm 2 PCS	2  M8*40mm 14 PCS	3  M8*70mm 2 PCS	4  1 PC	A  D4*27cm 3 PCS	B  D8.5*35cm 2 PCS	C  D8.5*32cm 1 PC	D  D5*19cm 2 PCS	E  D8.5*30cm 1 PC	F  D8.5*30cm 2 PCS
---	--	---	---	---	---	---	---	--	---

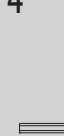
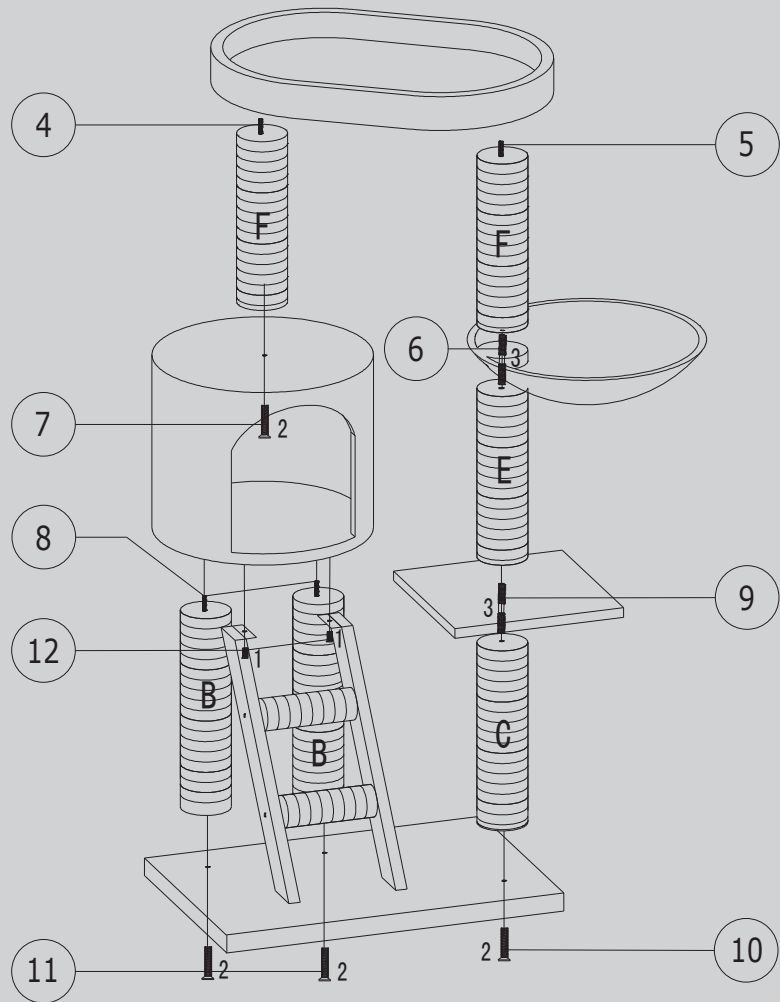
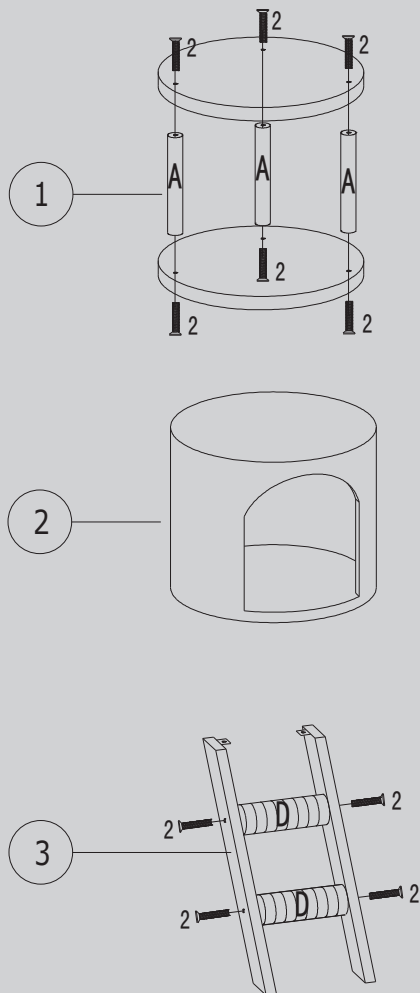

(DE) Bitte halten Sie die Reihenfolge der Arbeitsschritte 1,2,3,... von der Skizze ein.
 (FR) Veuillez suivre la sequence du Workflow 1, 2, 3 ...comme vous pouvez le voir sur le schema.
 (EN) Pls follow the sequence of the workflow 1,2,3,... as you can see on the draft.